

## Wiring

Having correctly identified the wiring from your existing light fitting, remove the existing cable from quick fit block then pull the mains wire through the hole and connect to the quick fit connection block inside the product in the following way:

Fig 1

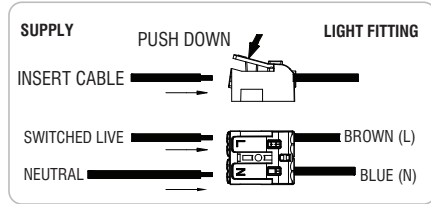

Having correctly identified the wiring from your light fitting, pull the wire through the hole and connect to the connection block(not supplied) in the following way:

This unit is double insulated and must not be earthed. If there are any incoming earth cables, they must be joined together and well insulated with good quality insulation tape.

Fig 2

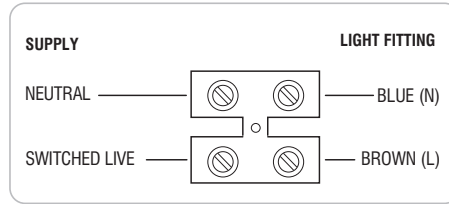

## Check that...

You have correctly identified the wires. The connections are tight. No loose strands have been left out of the connection block. Reseal the approved outdoor rated external terminal block

## Technical data

Supply Voltage: 220-240 V~, 50 Hz

Bulb Type: 15W LED module (SMD) CCT, 3000/4000/6000K This product contains a light source of energy efficiency class **E**.

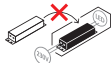
 Non-replaceable light source |  Non-replaceable control gear

 Conformity with all relevant UKCA Directive requirements.

 Conformity with all relevant EC Directive requirements.

 The power supply is Double Insulated and does not require connection to an Earth circuit.

 This product is not suitable for dimming.

 This product is rated at IP65.

 Caution! Risk of electric shock!

 Waste electrical products should not be disposed of with household waste. Please recycle where facilities exist. Check with your Local Authority or local store for recycling advice.

## Care and Safety

Live Voltages may be present in this unit even when turned off or when completely disconnected.

We recommend cleaning with a soft dry cloth. Do not use solvents or abrasive cleaners as these could damage the finish.

For your safety, always switch off the power supply before changing lightbulbs, or cleaning.

 This LED's are protected by a PC shade. The shade part must be replaced immediately should it become cracked or damaged. This fitting must not be used without the PC shade in place.

For further information, please visit <https://www.lighting-info.co.uk/108745>

V2 19/12/2023

UK Manufacturer: BH17 7BY

EU Manufacturer: Brilliant AG,  
Brilliantstrasse 1, D-27442 Gnarnenburg

saxby  
lighting

Instruction manual

# Rond Plus CCT

108745, 108746



108745



108746

[www.saxbylighting.com](http://www.saxbylighting.com)

saxby  
lighting

Thank you for purchasing this light fitting. Please read the instruction carefully before use to ensure safe and satisfactory operation of this product. Please retain these instruction for future reference.

## Warning

The power supply is Double Insulated and does not require connection to an Earth circuit.

Please read these instructions carefully before commencing any work.

This unit must be fitted by a competent and qualified electrician.

Install in accordance with the IEE Wiring regulations and current Building Regulations.

Check the pack and make sure you have all the parts listed.

To prevent electrocution switch off at the mains supply before installing or maintaining this fitting. Ensure other persons cannot restore the electrical supply without your knowledge. If you are in any doubt, please consult a qualified electrician.

If replacing an existing fitting, make a careful note of the connections.

This product is suitable for location in or near a marine environment.

Never put anything on the product or hang anything on any part of this product.

This system contains non-replaceable parts and cannot be serviced. If damage occurs the part should be scrapped.

Waste electrical products should not be disposed of with household waste. Please recycle where facilities exist. Check with your local authority or retailer for recycling advice.

## Layout

Plan the desired layout of these fittings carefully, ensuring the cables will reach the distances between the junction box and the each light fitting.

Avoid locating any cables in positions that would cause a hazard. Position cables and outdoor rated junction boxes (not supplied) away from areas where they may be at risk from being cut, trapped or damaged.

We recommend that you use H05RN-F specification cable (not supplied) which is an outdoor grade, rubber sheathed cable.

The mains supply cable must have a minimum cross section area of 1.0mm<sup>2</sup>.

Cables must be protected using suitable conduit or plastic trunking.

This product can be ceiling and wall mounted.

This product must be mounted out of arms reach.

This product is suitable for outdoor and indoor use.

## PIR data for 108746 only

This PIR sensor can't be adjusted. default setting as below:

10 lux on/off. 100° detection angle, Max 6m detection range with 45 sec hold timer function, installation height Max 4m.

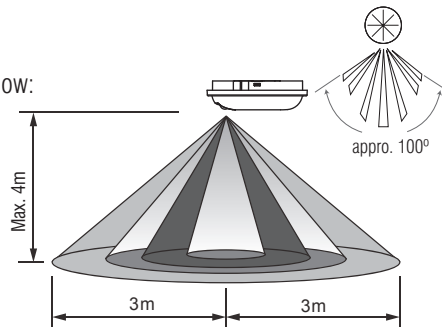

## Installation

Existing fittings must be completely removed before installation of a new product. Before removing the existing fitting, carefully note the position of each set of wires.

Note that the switch is turned off before installation.

Ensure that the screws and cable entry points are sealed to maintain the IP rating of the product.

After deciding the layout of the light fittings ensure that the cables are long enough to connect to desired positions.

- Determine the position of your light fitting taking into account the entry position of the cable and the **ARROW** indicating which **WAY UP** the base is to be fitted. Make sure there is sufficient cable coming out of the wall to connect to the terminal block. Ensure that the mounting surface is solid, preferably a brick or block wall and ensure that there are no other cables or pipes beneath the surface.
- Press the clips on both side of the lamp body to release the bracket.
- Using the bracket as a template, mark the position of the mounting holes. Drill holes and fit supplied wall plugs (suitable for masonry only - for other surfaces use appropriate fixings). Feed the incoming mains supply cable through the grommet entry hole. Fix the bracket to the ceiling or wall using the supplied screws.
- Unscrew two screws to open the cover of the terminal block fixed on the product to wire as the detailed wiring diagram. Then refit the cover.
- Refit the lamp body in place.
- Replace fuse or circuit breaker and switch on. Your light is now ready for use.

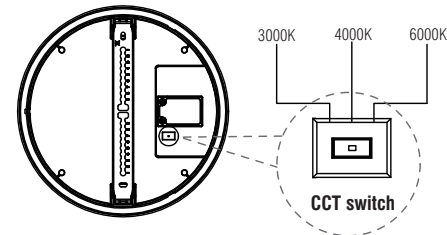

This product is colour changing and can be either warm white (**3000K**) or cool white (**4000K**) or daylight white (**6000K**).

Choose your preferred colour before installing by using the CCT switch back of the product.

